

승 인 원 APPLICATION FOR APPROVAL

Product : Topview 5630 White SMD LED

Part No. : IWS-S5234-PW-80K1

Date : 2015. 03. 18 Ver. 0.1

Customer :

Checked By	Checked By	Checked By	Checked By	Checked By	Approval

Manufacturer : ITSWELL Co., LTD.

Checked By	Checked By	Checked By	Checked By	Checked By	Approval
Approved					



ITSWELL Co., Ltd
193, Namdongseo-ro, Namdong-gu, Incheon 405-817 KOREA
TEL:+82-32-813-1801, FAX:+82+32-816-1900
URL: <http://www.itswell.com>

Table of Contents

< Contents >	< Page >
1. Features	3
2. Applications	3
3. Outline Drawing and Dimension	3
4. Absolute Maximum Ratings	4
5. Electro-optical Characteristics	4 ~ 5
5.1 Luminous Intensity Rank	4
5.2 Forward Voltage Rank	4
5.3 Color Coordinates Rank	4 ~ 5
6. Typical Characteristics Curves	6
7. Dimension of Tape / Reel	7
7.1 Tape Dimension	7
7.2 Reel Dimension	7
8. Packing Dimension	8
9. Precaution in use	9 ~ 14
9.1 Soldering Conditions	9 ~ 10
9.2 Cleaning	10
9.3 Heat Generation	10
9.4 Storage	10 ~ 11
9.5 Static Electricity	12 ~ 13
9.6 Exposure to Specific Material	13
9.7 Handling LED	14
10. Reliability	15
10.1 Reliability Test Item	15
10.2 Criteria for Judging the Damage	15
11. Part Name Description	16
12. Rank Description	16
13. Attention : ESD Protection	16
14. Specification Review History	17

Top view 5630 SMD LED

IWS-S5234-PW-80K1

1. Features

- 1 Chip High-Luminosity SMD LED
- 5.6 x 3.0 x 0.9 mm (L x W x H), 4-Pin, Small Size Surface Mount Type
- Wide Viewing Angle
- Long Operating Life
- MSL 3

2. Applications

- Automotive: Backlight in Dashboard and Switch
- Lighting Device: Indicator, General Lighting
- Camera Flash, Hand Carrier Flash
- General Use

3. Outline Drawing and Dimension

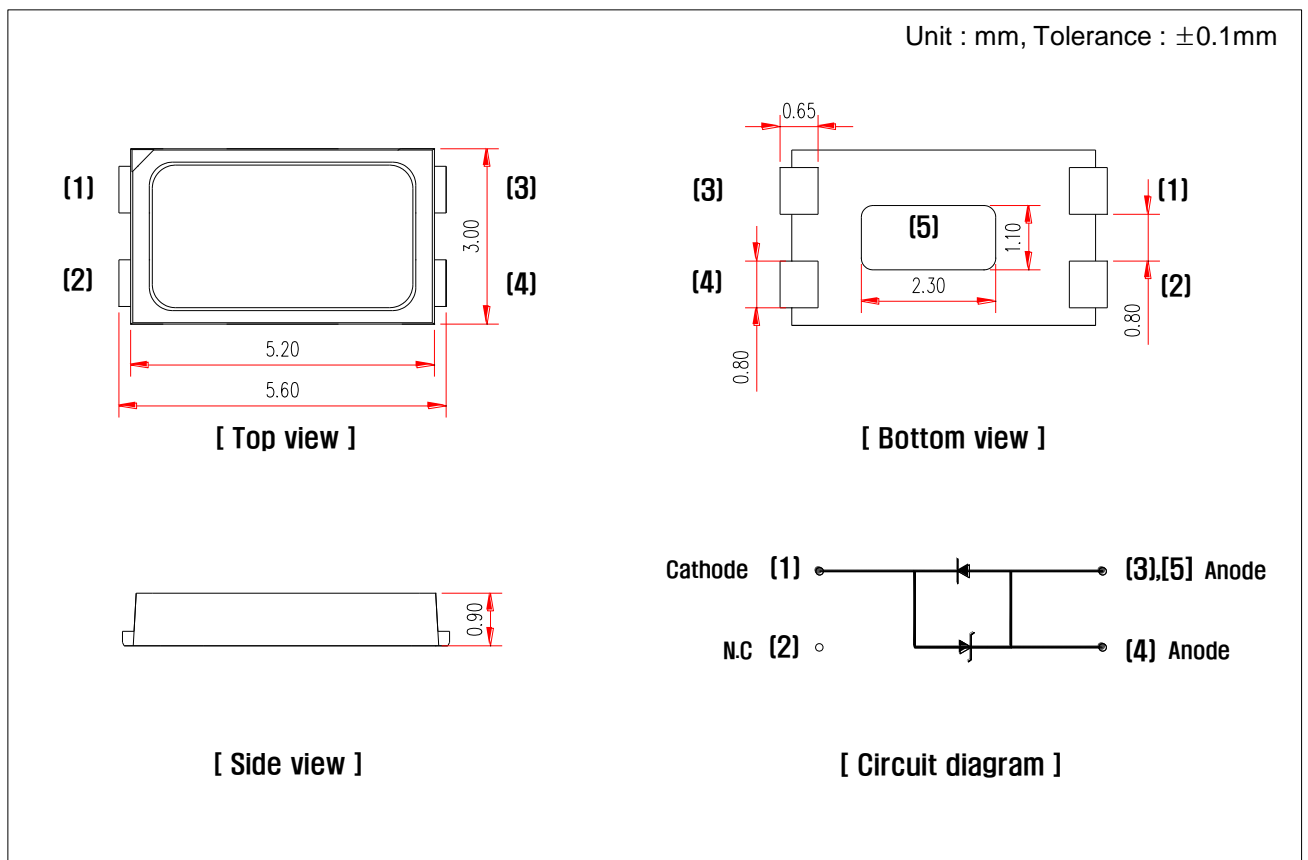

Note

1. All dimensions are in millimeters
2. All dimensions without tolerances are for reference only

4. Absolute Maximum Ratings($T_a = 25\text{ }^\circ\text{C}$)

Parameter	Symbol	Value	Unit
Power Dissipation	P_d	306	mW
Continuous Forward Current	I_F	90	mA
Peak Forward Current ^{*1}	I_{FP}	300	mA
Operating Temperature	T_{opr}	-40 ~ 85	$^\circ\text{C}$
Storage Temperature	T_{stg}	-40 ~ 100	$^\circ\text{C}$
Soldering Temperature	T_{sol}	260 (5sec)	$^\circ\text{C}$
Junction Temperature	T_J	125	$^\circ\text{C}$
Thermal Resistance	R_{thj-b}	21.1	$^\circ\text{C}/\text{W}$

*1 Duty ratio = 1/10, Pulse width = 0.1ms

5. Electro-optical Characteristics($T_a = 25\text{ }^\circ\text{C}$)

Parameter	Symbol	Conditions	Min.	Typ.	Max.	Unit.
Forward Voltage ^{*2}	V_F	$I_F = 60\text{ mA}$	2.8	-	3.4	V
Reverse Voltage	V_R	$I_R = 5\text{ mA}$	0.7	0.8	1.5	V
Luminous Intensity ^{*3}	I_v	$I_F = 60\text{ mA}$	6,500	-	9,500	mcd
Color Coordinates ^{*4}	CIE x CIE y	$I_F = 60\text{ mA}$	Refer to Color Coordinates Rank			
Viewing Angle ^{*5}	$2\theta_{1/2}$	$I_F = 60\text{ mA}$	-	120	-	$^\circ$
Color Rendering Index ^{*6}	CRI	$I_F = 60\text{ mA}$	80	-	-	-

*2 Forward Voltage has a tolerance of $\pm 0.05\text{ V}$.

*3 Luminous Intensity is tested by a tester calibrated by CAS 140B(CIE LED_B) and has an accuracy of 10%

*4 Color Coordinates has an accuracy of ± 0.01 .

*5 Viewing Angle is the angle until 50% of brightness measured from the front part of LED.

*6 Color Rendering Index has an accuracy of ± 1 .

5.1 Luminous Intensity Rank

Rank	Luminous Intensity (mcd)
E2	6500 ~ 7500
F2	7500 ~ 8500
G2	8500 ~ 9500

5.2 Forward Voltage Rank

Rank	Forward Voltage (V)
0	2.8 ~ 2.9
1	2.9 ~ 3.0
2	3.0 ~ 3.1
3	3.1 ~ 3.2
4	3.2 ~ 3.3
5	3.3 ~ 3.4

5.3 Color Coordinates Rank ($I_f = 60 \text{ mA}$, $T_a = 25 \text{ }^\circ\text{C}$)

BC-1	
5500 ~ 6022 K	
x	y
0.3229	0.3142
0.3198	0.3585
0.3325	0.3687
0.3324	0.3227

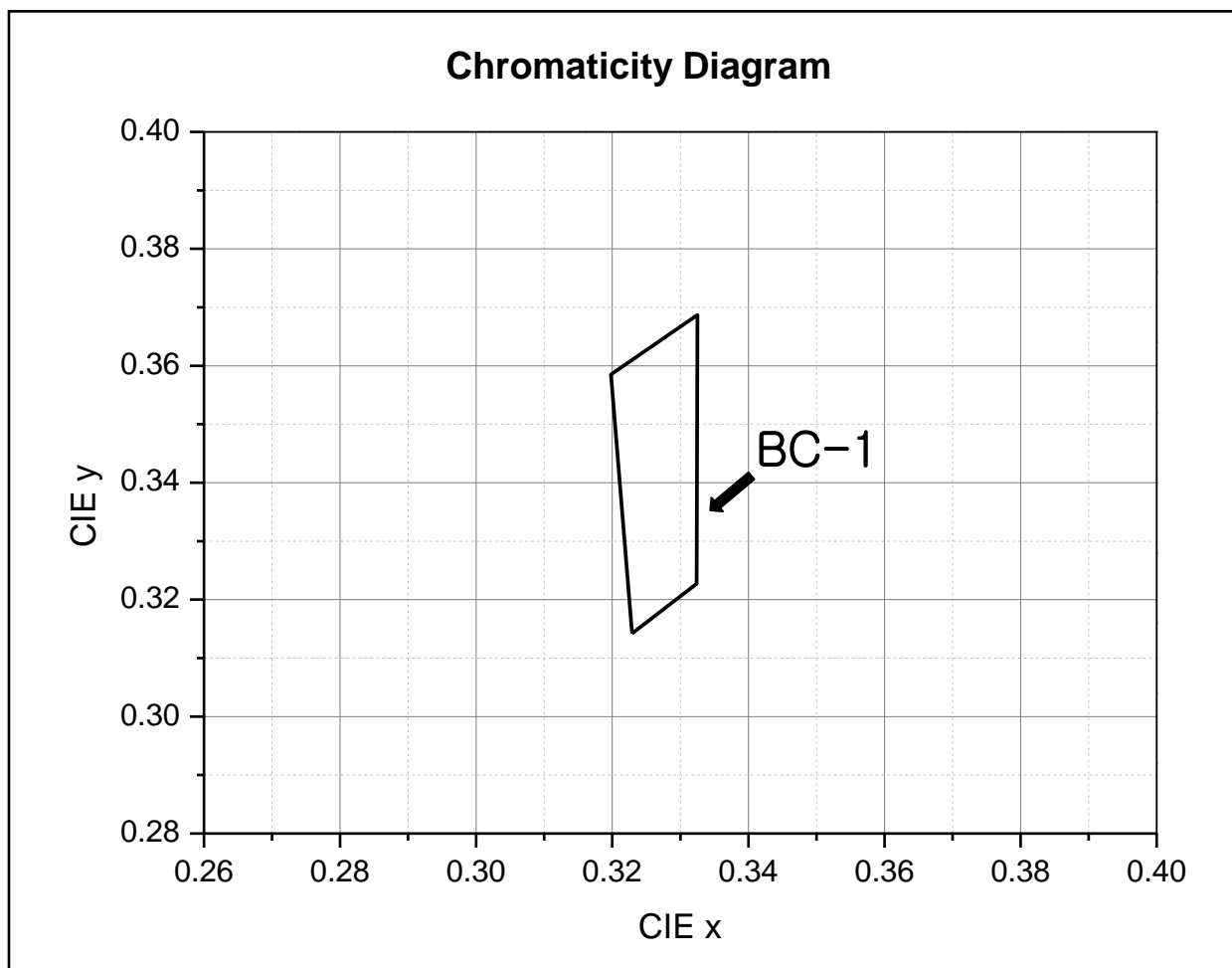

6. Typical Characteristics Curves

Forward Current vs. Forward Voltage

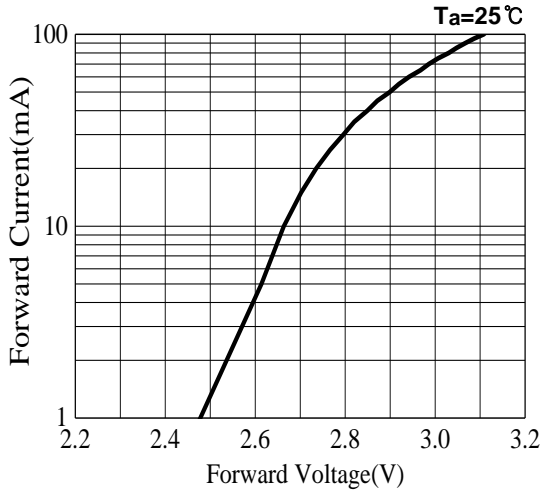

Forward Current vs. Solder Temperature

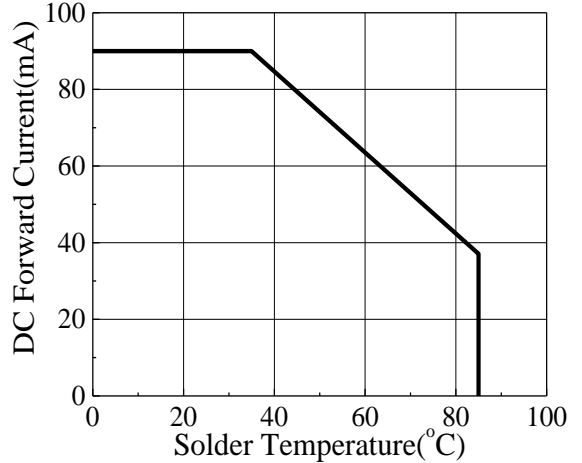

Relative Luminous Intensity vs. Solder Temperature

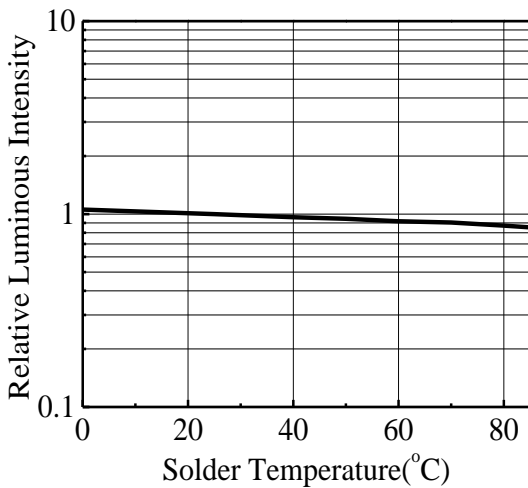

Relative Luminous Intensity vs. Forward Current

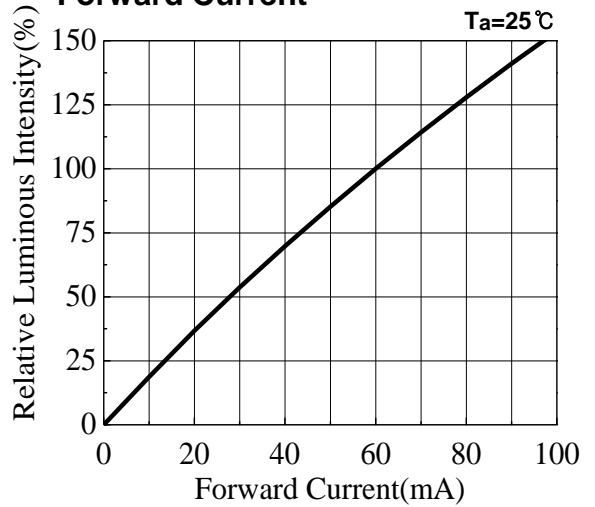

Relative Intensity vs. Wavelength

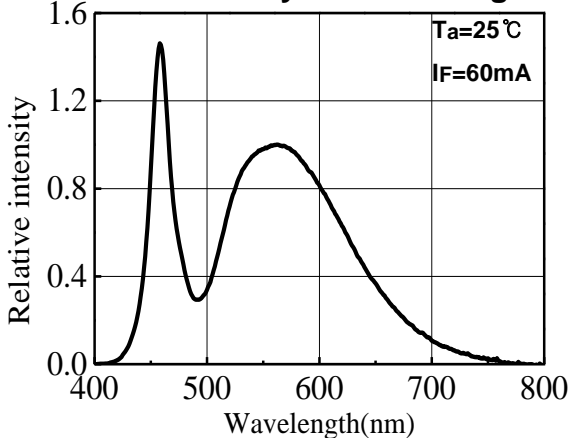

Radiation Diagram

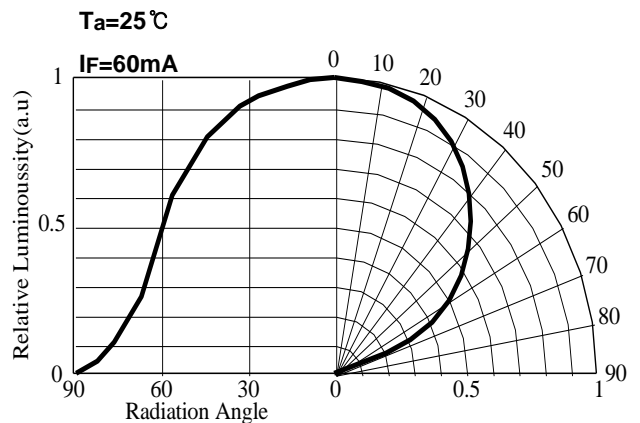

7. Dimension of Tape / Reel

7.1 Tape Dimension

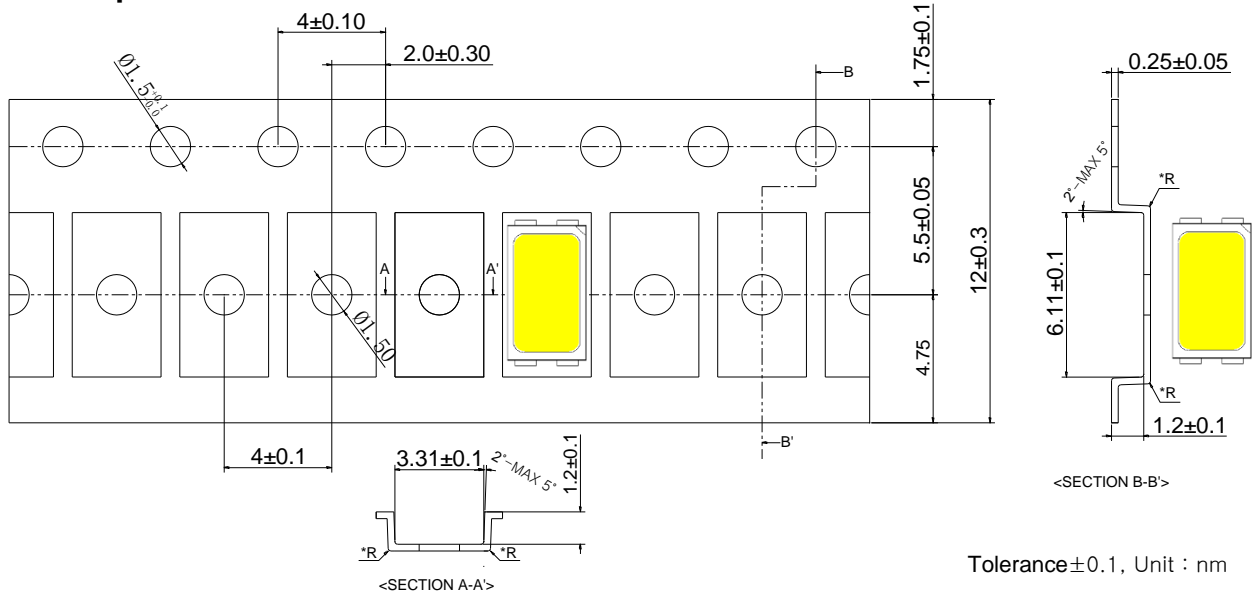

7.2 Reel Dimension

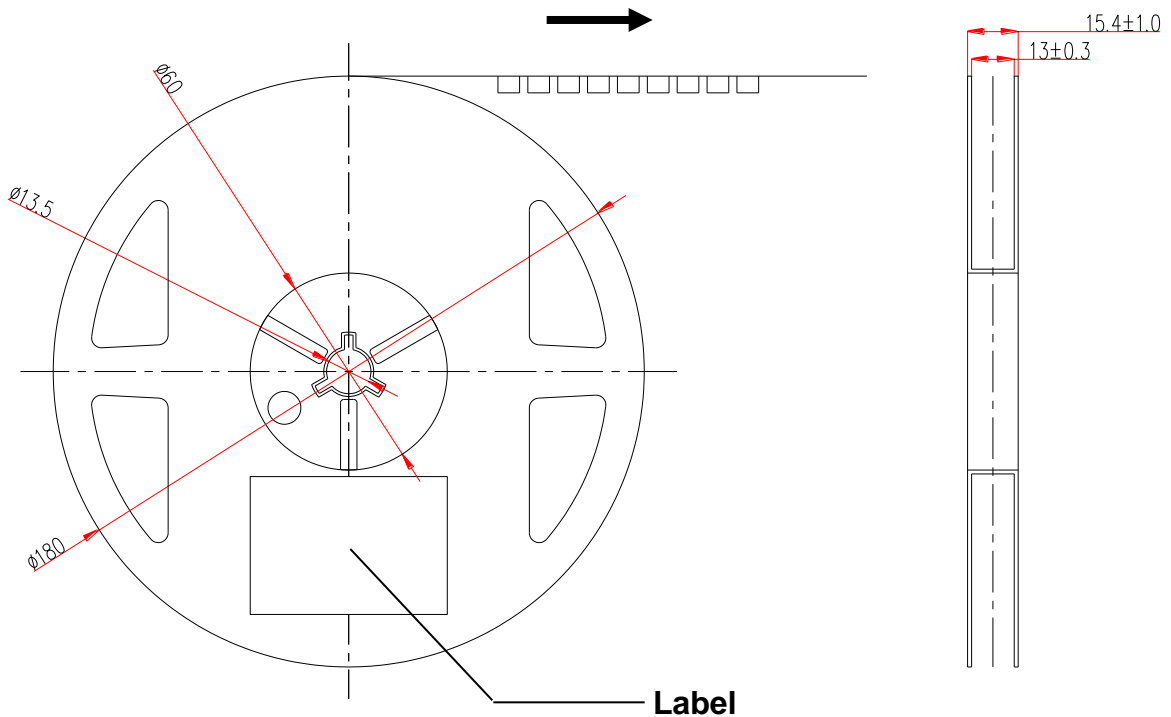

8. Packing Dimension

Unit :mm

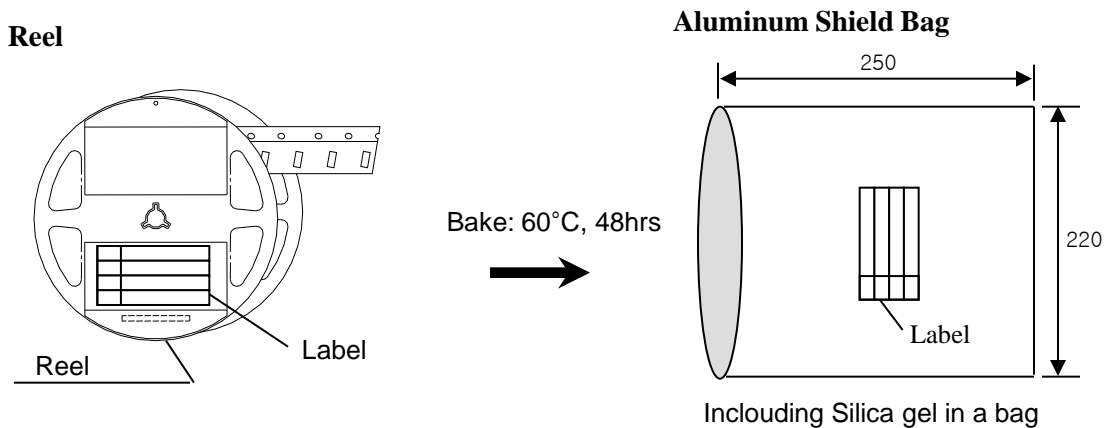

Al Pack Label, Reel Label (70 × 37)

ITSWELL				
Lot :	IWS-S5234-PW-80K1			
	MIN	AVG	MAX	STD
V _F [volt]				
I _v [mcd]				
CCT [K]				
Q'ty :	yyyy/mm/dd			

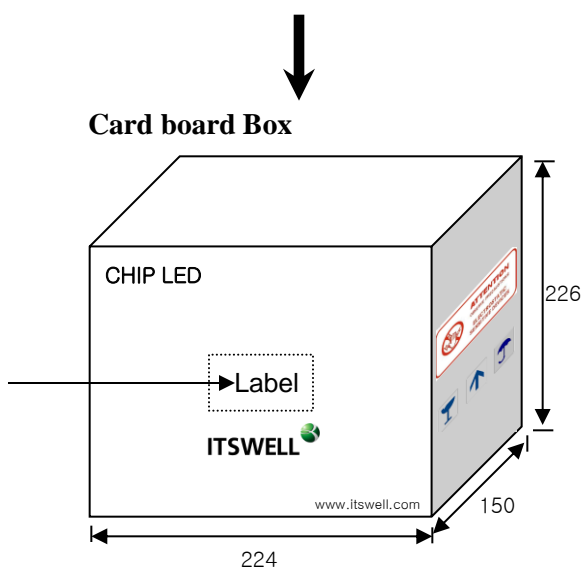

	Dimensions (mm)	Reel / Box	Q'ty / Box(pcs)
Reel	Φ180mm, 15mm Width	—	3,000 Max
Al Shield Bag	250x220	—	3,000 Max
Card board Box	224x150x226	9 Max	27,000 Max

9. Precaution in use

9.1 Soldering Conditions

- When soldering Power SMD, Heat may affect the electrical and optical characteristics of the LEDs.
Power SMD를 납땀할 때, 발생하는 열은 LED의 전기 및 광학적 특성에 영향을 줄 수 있음.
- In soldering, do not stress the lead frame and the resin part under the high temperature.
납땀할 때, 리드프레임 및 수지 영역에 높은 온도 가하는 것을 금함.
- The silicone part should be protected from mechanical stress or vibration until the Power SMD return to room temperature after soldering.
납땀 후, Power SMD가 상온 상태가 될 때까지 실리콘 영역은 기계적 부하 및 진동으로부터 보호되어야함.
- Preliminary heating to be at 120~150 °C max. for 120 Seconds max.
예열은 최대 120초 동안 최대 120 ~ 150 °C 에서 권장함.
- Soldering heat to be at 260 °C max. for 5 sec. Max.
납땀 열은 최대 5초 동안 260 °C 에서 권장함.
- Manual Soldering is Not more than 3 sec @MAX 350 °C, under soldering iron.
수납은 인두기 최대 350 °C 에서 3초보다 길게 하는 것을 금함.
- Do not assemble at atmosphere containing of humidity, condensation, chlorine and Volatile Organic Compounds.
습기, 결로, 염소 및 휘발성 유기 화합물이 포함된 대기에서 조립을 금함.
- Recommend assembling the LEDs in last order to prevent delamination when implementing surface mounting technology.
SMT 시, 박리를 방지하기 위해 LED는 제일 마지막에 조립하는 것을 권장함.
- When bifacially implementing surface mounting technology, LEDs assembling should be completed within 12 hours.
양면으로 SMT 시, LED 조립은 12시간 이내에 완료되어야함.
- When the LEDs containing moisture may vaporize and expand during soldering, it may cause delamination and optical degradation of the LEDs.
습기를 함유하고 있는 LED가 납땀하는 동안에 증발하거나 팽창이 되어 박리 및 광학 특성 저하 시킬 수 있음.

< Lead Free >

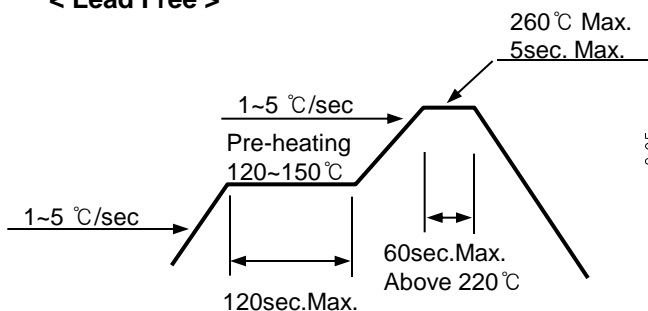

<Recommendable soldering pattern>

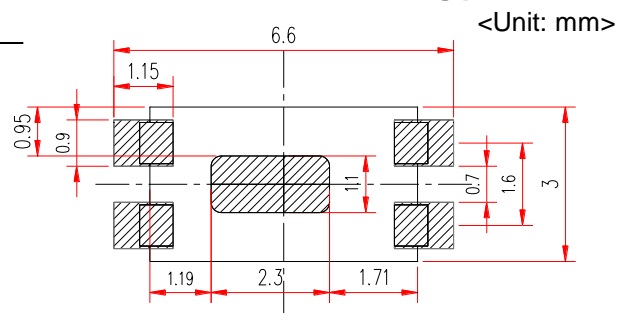

9.1 Soldering Conditions

- The use of flux in soldering material may make the LEDs discolored by thermal and lighting acceleration factor. so, recommend to clean a residual flux with Isopropyl Alcohol after soldering.
납땀 소재에서 Flux의 사용은 열과 빛의 축진 인자에 의해 LED의 변색이 될 수 있으므로 납땀 후에 이소프로필알코올을 사용하여 잔여 Flux 세정을 권장함.

9.2 Cleaning

- If user needs cleaning of the LEDs, use of Isopropyl Alcohol or Ethylene Alcohol is recommended in 5 minutes at room temperature. and dry at room temperature for 15 minutes before use the LEDs. If user uses other than Isopropyl Alcohol or Ethylene Alcohol as cleaning material, it should be not dissolve the LEDs.
LED의 세정이 필요하면, 사용 전에 상온에서는 5분 이내에 건조한 상온에서는 15분동안 이소프로필알코올 또는 에틸렌알코올로 세정 권장함. 만약 세정 물질로 이소프로필알코올 또는 에틸렌알코올 이외의 것을 사용하면, LED가 파손될 수 있음.
- Freon solvents should not be used to clean the LEDs because of worldwide regulations.
국제 규정으로 LED의 세정에 프레온 용제를 사용을 금함.

9.3 Heat Generation

- When the LEDs are illuminating, operating current should be decided after being considering the ambient maximum temperature.
LED를 구동 시킬 때, 구동 전류는 주변 최대 온도를 고려한 후에 결정 되어야 함.
- Please consider the heat generation of the LED when it is designed the PCB.
PCB를 디자인 할 때, LED 열 발생을 고려하여 설계하는 것을 권장함.

9.4 Storage

- The LEDs must be stored in a clean environment.
LED는 깨끗한 환경에 보관 해야함.
- Do not expose the LEDs to direct sunlight.
직사광선에 LED를 노출시키는 것을 금함.
- Before opening the package, the LEDs should be kept at 30℃ or less and 60%RH or less.
포장을 개봉 전에, LED는 30℃ 미만 또는 상대습도 60% 미만에 보관 해야함.
- The LEDs should be used within 168 hours (1 week) after opening the package.
LED는 포장 개봉 후에 168시간(1주) 이내에 사용 해야함.
- The LEDs should be used within a year.
LED는 1년 안에 사용 해야함.

9.4 Storage

- In case of the LEDs is used 3 months later since user received the LEDs, the LEDs is recommended to be stored in the nitrogen chamber. and user should inspect discolored appearance before using the LEDs.
LED를 수령한지 3개월이 지난 후에 사용할 경우, LED는 질소실에 보관하고 사용 이전에 변색을 확인 해야함.
- After opening the package, the LEDs should be kept at 30°C or less and 20%RH or less.
포장 개봉 후에, LED는 30°C 미만 또는 상대습도 20% 미만에 보관 해야함.
- If the moisture absorbent material (silica gel) has faded away or the LED have exceeded the storage time, baking treatment should be performed using the following conditions.
 - Baking treatment: 60°C ±5 for 48 hours.
만약 수분 흡수 물질(방습제)이 사라지거나 LED의 보관 시간이 경과하면, 다음과 같은 조건으로 Baking 해야함.
 - Baking 처리 : 60°C ±5에서 48시간 동안.
- When restoring unused the LEDs with anti-electrostatic bag, seal off the anti-electrostatic bag so that no gas and humidity can get it.
제전봉투에 사용되지 않은 LED를 보관할 때, 기체 및 습기가 침투하지 못하게 제전봉투를 밀봉 해야함.
- When storage the LEDs in the corrugated cardboard, it may make the LEDs discolored because of minute sulfur gas from the corrugated cardboard.
골판지 상자에 LED를 보관할 때, 골판지 상자에서 나오는 미세한 황 기체로 인한 LED의 변색 될 수 있음.
- Do not use over 10 days in case of using corrugated cardboard.
골판지 상자를 사용하는 경우에 10일을 경과하면 안됨.
- Recommend corrugated cardboard containing sulfur less than 850ppm when It is Inevitable use of corrugated cardboard.
골판지 상자의 사용이 불가피한 경우에 황의 농도가 850ppm 보다 적게 함유된 골판지 상자의 사용을 권고함.
- Recommend using material type of PP or PET tray to storage the PCBs or assemblies containing the LEDs. and Insert the silica gel into each of tray.
LED를 포함하는 PCB 또는 조립품은 폴리프로필렌 또는 폴리에틸렌테레프탈레이트 재질의 상자 사용을 권고함.
- Use the anti-electrostatic box with anti-electrostatic cover to prevent Volatile Organic Compounds, sulfur gas and humidity when storing the bundle of the PCBs or assemblies containing the LEDs.
LED를 포함하고 있는 PCB 및 조립품의 묶음을 보관할 때, 유기화합물, 황 기체 및 습기 침투의 방지를 위해 제전덮개가 있는 제전박스를 사용 권장함.
- Do not stack the PCBs or assemblies containing LEDs at shorter distance than 2 centimeters.
LED를 포함하고 있는 PCB 및 조립품을 2센치미터 간격보다 좁게 적재는 것을 금함.

9.4 Storage

- Do not use bubble wrap directly on top of LEDs. It may cause damage the LEDs.
LED가 손상될 수 있으므로, LED의 상단에 바로 포장 에어캡을 닿게 하는 것을 금함.
- Do not use rubber band.
고무줄 사용을 금함.

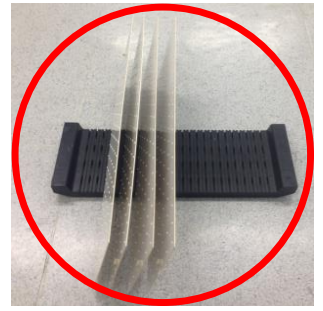

<Humidity Indicator>



<Bulk Packing>



<Taping Packing>



9.5 Static Electricity

- Static electricity or surge voltage damages the Power SMD . It is recommended that a wrist band or an anti-electrostatic glove be used when handling the LEDs.
정전기 또는 서지전압은 Power SMD에 손상을 줄 있음. LED를 다룰 때 손목 밴드 또는 제전 장갑 사용을 권장함.

9.5 Static Electricity

- A tip soldering iron is requested to be grounded. An ionizer should also be installed where risk of static.
인두기는 접지시키고 이온화 장치는 위험 요소가 정적인 곳에 설치 해야함.
- All devices, equipment and machinery must be properly grounded (via 1MΩ). It is recommended that measures be taken against surge voltage to the equipment that mounts the Power SMD.
모든 장치, 장비 및 기계는 1MΩ의 저항을 통해서 반드시 적절히 접지 되어야함. Power SMD를 탑재한 장비는 서지전압을 감안하여 측정 권고함.
- If the LEDs is applied at voltage over maximum value, it may cause damage or destruction of the LEDs.
LED가 전압 최대치를 넘게 적용되면, LED의 손상이나 파괴를 일으킬 수 있음.
- The LEDs damaged or destructed by anything may cause an increase in leak current, lowered turn on forward voltage, or the LEDs at low forward current.
어떤 요인에 의해 손상 받거나 파괴된 LED는 누설전류, 낮아진 구동 전압 또는 낮은 구동 전류를 야기 할 수 있음.
- It is important to eliminate the possibility of surge current when user designs circuit.
회로를 설계할 때, 서지전류의 가능성을 제거하는 것을 권고함.

9.6 Exposure to Specific Material

- When the LEDs are exposed to specific material such as oxidizing material, rubber, paper, solder cream, sulfur, chlorine or other halogen compound, LEDs surface in silver-plating part of Lead Frame can be discolored.
LED가 산화물질, 고무, 종이, 솔더크림, 황, 염소 및 다른 할로젠 화합물과 같은 특정 물질에 노출되면 리드프레임의 은도금 부분에서 변색이 일어날 수 있음.
- If LEDs surface in silver-plating part of Lead Frame are discolored, it can cause intensity degradation, change of color coordinates and open circuit.
리드프레임의 은도금 부분에서 LED의 표면이 변색 되면, 빛의 강도 감소, 표색계 변화 및 개방회로를 야기할 수 있음.
- Recommend user to use adhesive type of silicone in minimum quantity. It is because that epoxy used as adhesive(sealing) material easily makes the LEDs discolored by gas than silicone material.
접착(밀봉) 물질로서 에폭시가 실리콘 물질 보다 기체에 의한 LED의 변색이 쉽게 되므로, 최소한의 양으로 실리콘 물질의 접착제의 사용을 권고함.
- When user designs the LEDs assembly, consider about free air ventilation to avoid discoloration and outgas Volatile Organic Compounds easily.
변색을 방지하고 유기화합물을 쉽게 빠지게 하기 위해 공기의 원활한 환기를 고려하여 LED 조립품을 설계 해야함.
- When user designs products containing the LEDs, do not use oxidizing raw and subsidiary materials such as sulfur, chlorine, other halides, gaseous or corrosive materials or substances. Because the LEDs contain silver-plating part that may discolor over time when exposed to these materials. It may cause corroded or contaminated silver-plating of the LEDs may cause an open circuit.
LED를 포함하고 있는 제품을 설계할 때, 황, 염소, 여러 할로젠화물, 기체 또는 부식성 재료 및 성분과 같은 산화 원부자재 사용을 금함. 이러한 물질에 노출될 때 시간이 경과하면서 LED의 은도금 부분이 변색 될 수 있음. 이로인한 LED의 은도금 부분의 부식이나 오염은 개방 회로를 야기할 수 있음.

9.7 Handling LED

- User's working and testing environment can be a important factor to discolor. because unclean testing chamber or working place with wet floor may cause discolor of the LEDs.
젖은 바닥과 청결하지 않은 실험 공간 또는 작업 장소는 LED의 변색을 일으키므로 사용자의 작업 및 실험 환경을 고려해야함.
- When handling the LED with tools like tweezers or nipper, do not apply Mechanical Forces directly on LED's Surface.
집게 및 니퍼와 같은 공구로 LED를 다룰 때, LED의 표면에 직접적으로 기계적인 힘을 가하는 것을 금함.
- Do not directly touch LED's surface with hand . It may contaminate the surface and affect on optical characteristics.
LED의 표면을 직접적으로 손으로 만지면 표면 오염으로 광학 특성에 영향을 미치므로 이것을 금함.
- The LEDs should be handled from side because LED's molding material may be damaged with scratching on surface, piercing molding material and broking wire.
LED의 몰딩 물질은 LED의 표면의 스크래치, 몰딩부 뚫림 및 와이어 깨짐으로 손상의 영향이 있어 LED는 측면으로 다루야 함.
- When doing surface mounting technology, If the encapsulation material of the LEDs is silicone, do not any stress or pressure that may cause that emitting surface area of the LEDs resin can be cut, chipped, delaminate or deformed, causing wire bonding breaks and destruction of the LEDs.
SMT 시, LED의 봉지재가 실리콘이면 LED의 와이어 파손 및 파괴를 야기하는 LED수지의 발광 표면의 잘림, 부서짐, 갈라짐, 형태변형을 일으킬 수 있는 어떠한 스트레스 또는 압력을 가하면 안됨.
- Recommended that the picking up nozzle optimize wider than emitting surface area of the LEDs and setting so that it does not damage the silicone resin.
실리콘 수지에 손상을 피하기 위해 픽업노즐 사용 조건을 설정하고 픽업노즐은 LED의 발광 표면 부분보다 크게 설계 권고함.
- Maintain cleanness of picking up nozzle.
픽업노즐의 청결함을 유지 해야함.
- Dropping the LEDs may cause damage.
LED를 떨어뜨리는 것은 손상을 야기 할 수 있음.
- Do not contaminate emitting surface area of the LEDs.
LED의 발광 표면 부분 오염을 금함.

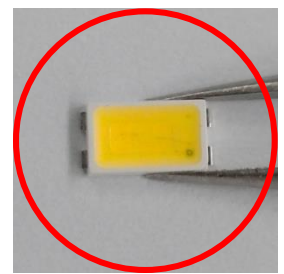
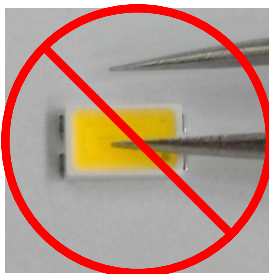

10. Reliability

10.1 Reliability Test Item

Test Items	Test Conditions	Notes
High Temperature Storage	100℃, 1,000hr.	0/25
Low Temperature Storage	-40℃, 1,000hr.	0/25
Temp. Humidity Storage	85℃, 85% RH, 1,000hr.	0/25
Steady State Operating life	25℃, 72mA, 1,000hr.	0/25
High Temperature Operating Life	85℃, 30mA, 1,000hr	0/25
Low Temperature Operating Life	-40℃, 60mA, 1,000hr.	0/25
Steady State Operating life Of High Humidity Heat	85℃, 85% RH, 45mA, 1,000hr.	0/25
Thermal Shock	-40℃(30min)↔100℃(30min.), 100 cycle	0/20
ESD	HBM, 100 pF, 1.5 kohm, 3 times	0/20

10.2 Criteria for Judging the Damage

Parameters	Test Conditions	Criteria for judgment
Luminous Intensity (I_v)	$I_F = 60 \text{ mA}$	> 70% of S
Forward Voltage (V_F)	$I_F = 60 \text{ mA}$	Less than 110% of U

* U means the upper limit of specified characteristics, S means initial value.

Top view 5630 SMD LED

IWS-S5234-PW-80K1



11. Part Name Description

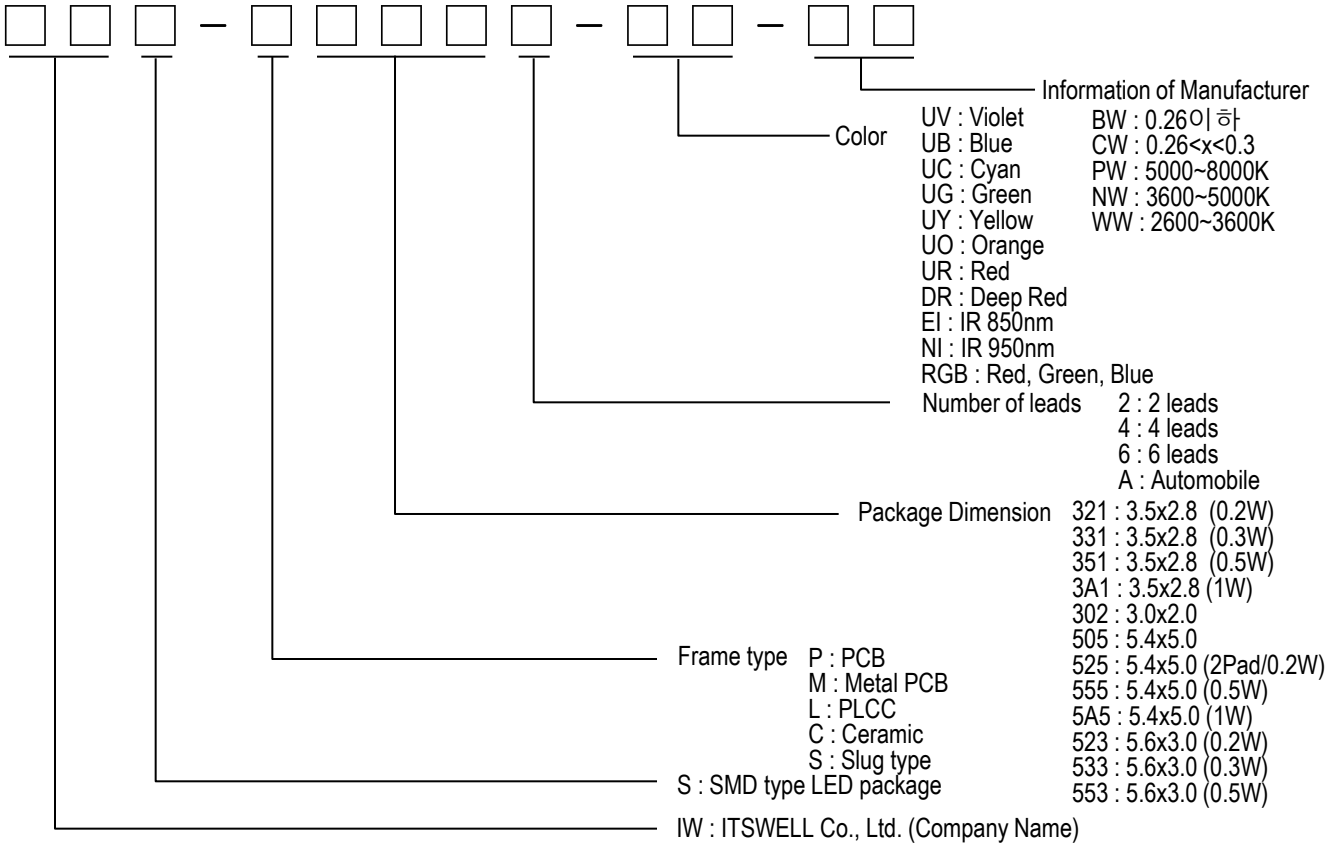

12. Rank Description

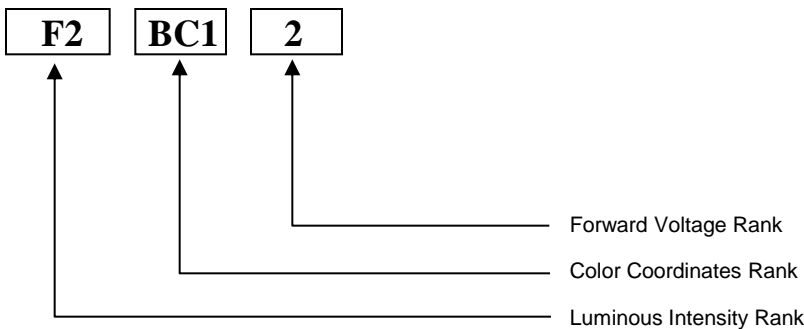

13. Attention : Electric Static Discharge (ESD) Protection



The symbol shown on the page herein to introduce 'Electro-Optical Characteristics'. ESD protection for GaP and AlGaAs based chips is still Necessary even though they are safe in low static-electric discharge. Material in AlInGaP, GaP, or/and InGaN based chips are STATIC SENSITIVE devices. ESD protection has to considered and taken in the initial design stage. If manual work/process is needed, please ensure the device is well protective from ESD during all the process.

14. Spec. Review History

Review Ver.	Date	Correction List	Etc.
Ver 0.1	2015.03.18	Established	