

# SPECIFICATION

Product : 3mm Red Dome Lamp

Part No. : IWL-R3R65F-XXX

Date : 2013. 07. 26 Ver. 2.0

Proposed By	Checked By	Checked By	Checked By	Checked By	Approval
Approved					

**Comment**



ITSWELL Co., Ltd  
58B-4L, 626-3 Gojan-dong, Namdong-gu, Incheon 405-817 KOREA  
TEL:+82-32-813-1801, FAX:+82+32-816-1900  
URL: <http://www.itswell.com>

# 3mm Dome LED Lamp

## IWL-R3R65F-XXX



### 1. Features

- Round Type Lamp
- 3mm Resin Mold Type
- Colored Red
- Transparency, Diffused or Colored Lens Type
- High Luminous Intensity
- Chip Material Based AlGaInP

### 2. Applications

- Automotive: Backlight in Dashboard and Switch
- Lighting Device: Indicator, Lighting
- Camera Flash, Hand Carrier Flash
- General Use

### 3. Outline Drawing and Dimension

\* Unit : mm, Tolerance :  $\pm 0.5$

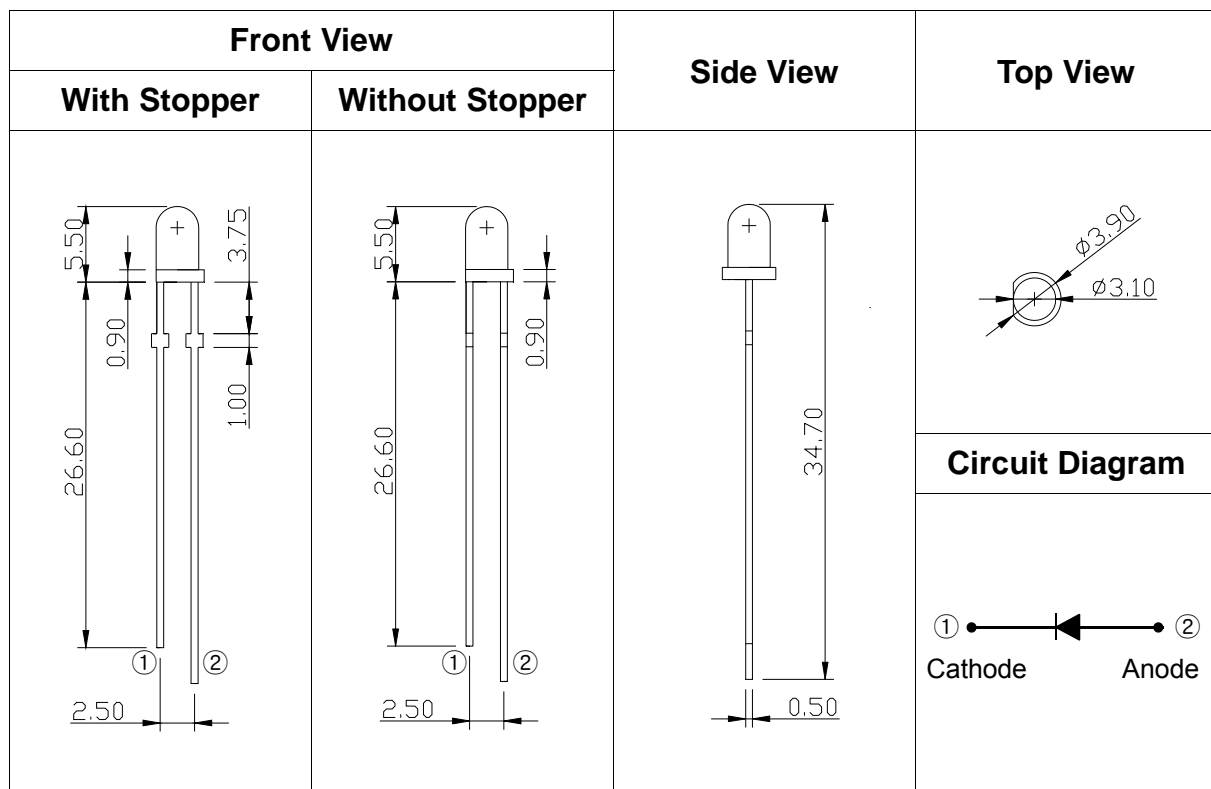

\* Note

1. All dimensions are in millimeters
2. All dimensions without tolerances are for reference only
3. Base Material : Fe Alloy
4. Molding : Epoxy
5. Lead Plating : Ag/Ni
6. Pb Free

### 4. Absolute Maximum Ratings (Ta = 25°C)

Parameter	Symbol	Value	Unit
Power Dissipation	$P_d$	72	mW
Continuous Forward Current	$I_F$	30	mA
Peak Forward Current <sup>*1</sup>	$I_{FP}$	100	mA
Operating Temperature	$T_{opr}$	-30 ~ 85	°C
Storage Temperature	$T_{stg}$	-40 ~ 100	°C
Soldering Temperature	$T_{sol}$	260 (5sec)	°C

\*1 Duty ratio = 1/10, Pulse width = 10ms

### 5. Electrical & Optical Characteristics (Ta = 25°C)

Parameter	Symbol	Conditions	Min.	Typ.	Max.	Unit.
Forward Voltage <sup>*2</sup>	$V_F$	$I_F = 20 \text{ mA}$	1.8	-	2.4	V
Reverse Current	$I_R$	$V_R = 5 \text{ V}$	-	-	10	μA
Luminous Intensity <sup>*3</sup>	$I_v$	$I_F = 20 \text{ mA}$	65	-	1,200	mcd
Dominant Wavelength <sup>*4</sup>	$W_D$	$I_F = 20 \text{ mA}$	615	-	650	nm
Viewing angle <sup>*5</sup>	$2\theta_{1/2}$	$I_F = 20 \text{ mA}$	-	65	-	deg.

\*2 Forward Voltage has a tolerance of  $\pm 0.05 \text{ V}$ .

\*3 Luminous Intensity is measured with an integrating sphere and has an accuracy of 10%.

\*4 Dominant Wavelength has an accuracy of  $\pm 2 \text{ nm}$

\*5 Viewing Angle is the angle until 50% of brightness measured from the front part of LED.

#### 5.1 Luminous Intensity Rank

Model	Rank	Luminous Intensity (mcd)
A	9	65 ~ 85
	A	85 ~ 110
	B	110 ~ 145
	C	145 ~ 190
B	F	325 ~ 425
	G	425 ~ 555
	H	555 ~ 720
	J	720 ~ 935
	K	935 ~ 1200

#### 5.2 Forward Voltage Rank

Rank	Forward Voltage (V)
1	1.8 ~ 2.4

#### 5.3 Dominant Wavelength Rank

Rank	Dominant Wavelength (nm)
A	615 ~ 620
B1	620 ~ 625
B2	625 ~ 630
C	630 ~ 635
HA	635 ~ 645
HB	645 ~ 650

### 6. Typical Characteristic Curve

**Forward Current vs. Forward Voltage**

$T_a=25^\circ\text{C}$

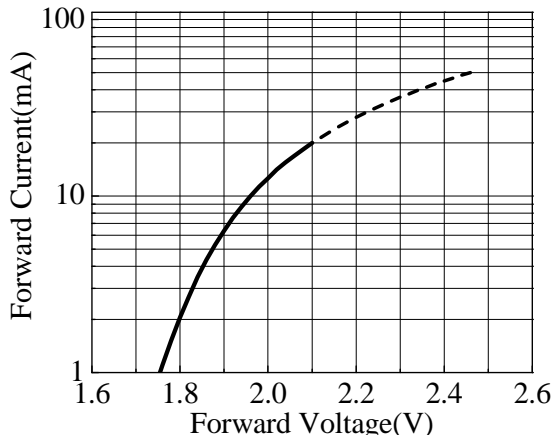

**Forward Current vs. Solder Temperature**

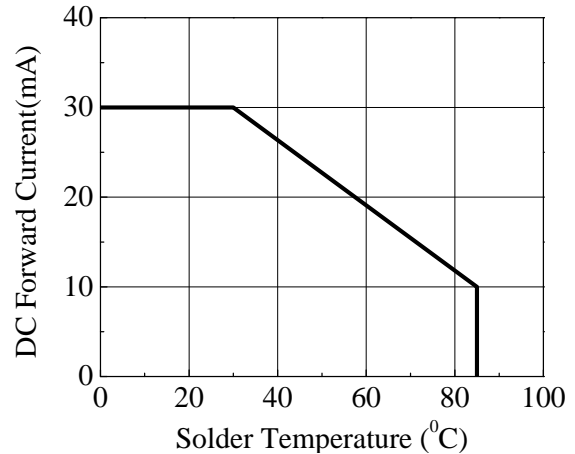

**Relative Luminous Intensity vs. Solder Temperature**

$I_f=20\text{mA}$

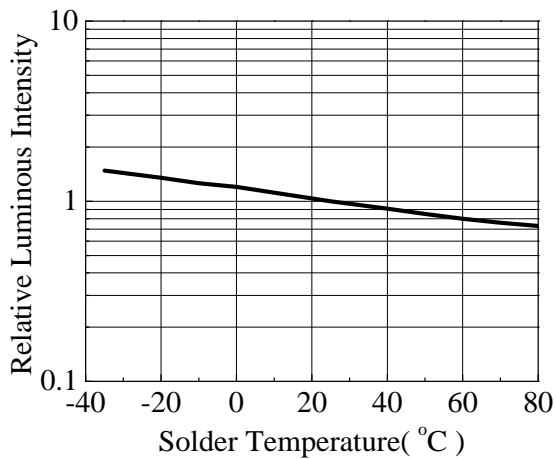

**Relative Luminous Intensity vs. Forward Current**

$T_a=25^\circ\text{C}$

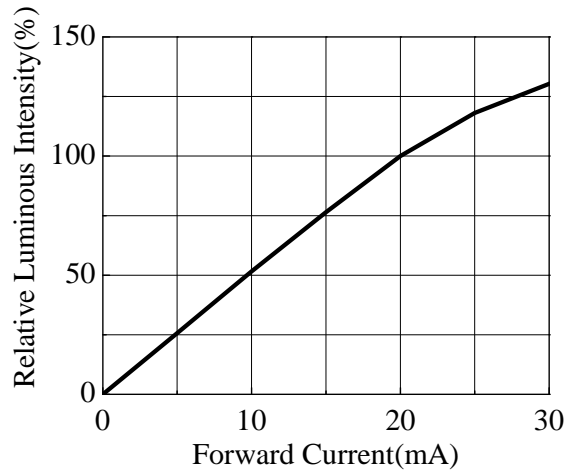

**Relative Luminous Intensity vs. Wavelength**

$T_a=25^\circ\text{C}$   
 $I_f=20\text{mA}$

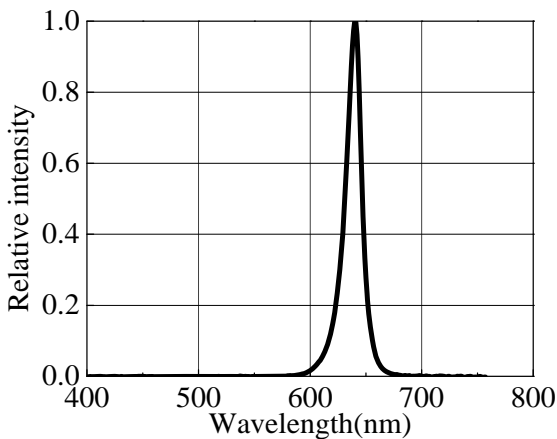

**Radiation Diagram**

$T_a=25^\circ\text{C}$   
 $I_f=20\text{mA}$

- Viewing Angle :  $65^\circ$

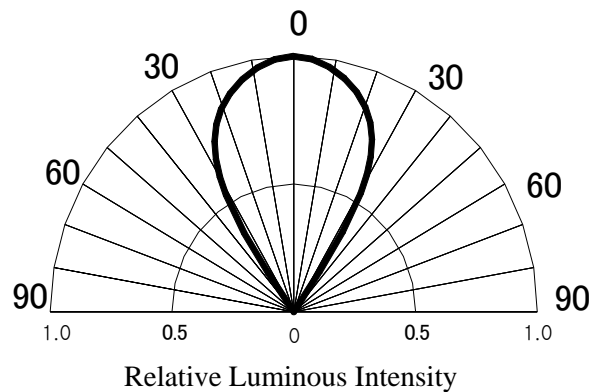

# 3mm Dome LED Lamp IWL-R3R65F-XXX



## 7. Packing & Tapping Dimension

### 7.1 Bulk Packing

#### - Bag packing

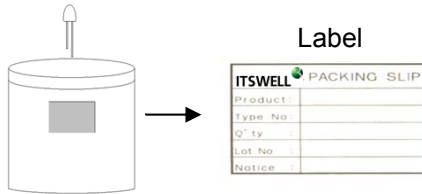

#### - Inner Box

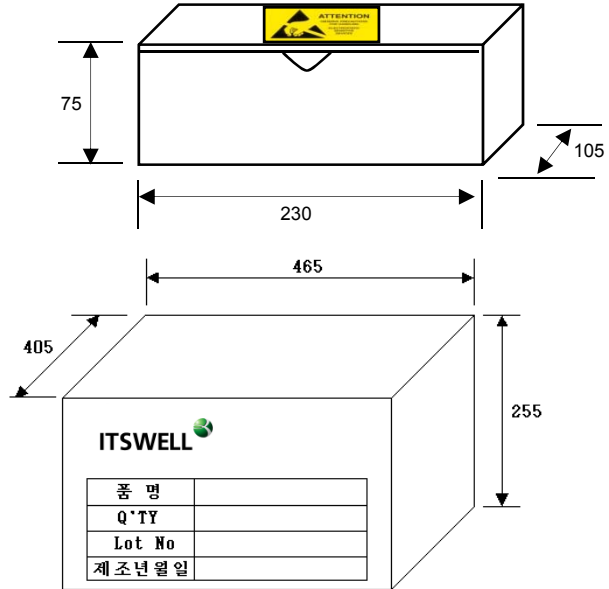

#### - Out Packing

- Maximum Inner Box 20 / 1 Box  
40,000 pcs/ 1 Box
- Out box material : Carton

### 7.2 Tapping Packing

#### - With Stopper

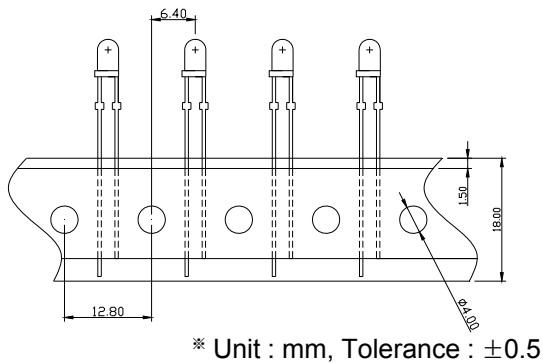

#### - Without Stopper

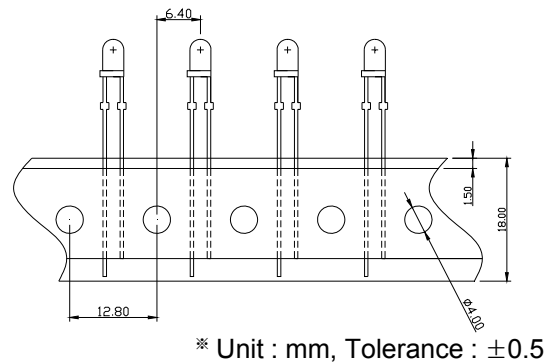

#### - Taping Box

- Tapping Box (Carton)
- 1 Tapping Box / Pack with Silica Gel
- 3,000 pcs/ 1 Tapping

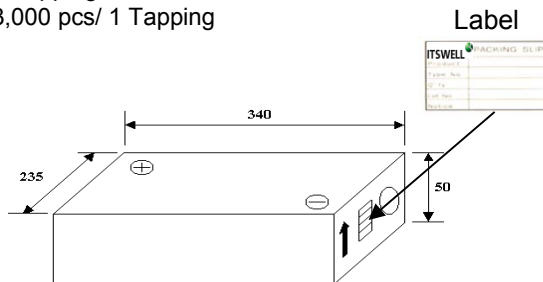

#### - Out Box

- Maximum 10 Tapping Box / Box
- 30,000 pcs/ Box

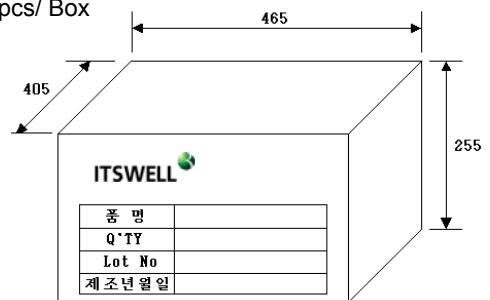

## 8. Precaution in use

### 8.1 Soldering Conditions

- When soldering DIP LED , Heat may affect the electrical and optical characteristics of the LEDs.
- In soldering, do not stress the lead frame and the resin part under the high temperature.
- The epoxy part should be protected from mechanical stress or vibration until the DIP LEDs return to room temperature after soldering.
- Preliminary heating to be at 120~150°C max. for 120 Seconds max.
- Soldering heat to be at 260°C max. for 5sec. Max.
- For manual Soldering is Not more than 3sec @MAX350°C, under soldering iron

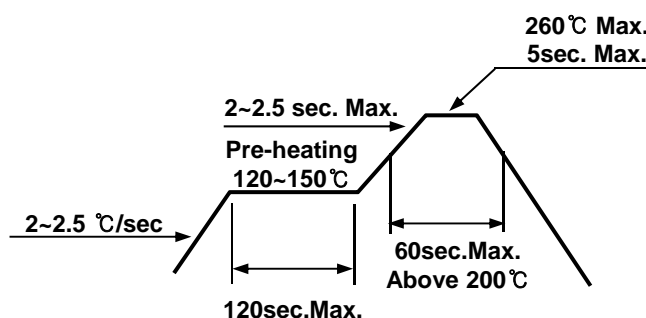

### 8.2 Storage

- Use within 7 days after opening packing. Store in 10 to 30 °C. DIP LED lead frames are plated Silver. The silver surface may be affected by environment which contain corrosive gases and so on. Please avoid condition which may cause the DIP LED to corroded, tarnish or discolor.

### 8.3 Static Electricity

- Static electricity or surge voltage damages the DIP LEDs. It is recommended that a wrist band or an anti-electrostatic glove be used when handling the LEDs.
- A tip soldering iron is requested to be grounded. An ionizer should also be installed where risk of static.
- All devices, equipment and machinery must be properly grounded (via 1MΩ). It is recommended that measures be taken against surge voltage to the equipment that mounts the DIP LEDs.

### 8.4 Cleaning

- Isopropyl Alcohol or Ethylene Alcohol is recommended in 5 minutes at room temperature. Don't use unspecified chemical may cause crack or haze on the surface of the epoxy resin.
- Before cleaning, a pre-test should be done to confirm whether any damage to the DIP LED will occur.
- Freon solvents should not be used to clean the DIP LEDs because of worldwide regulations.

## 9. Reliability

### 9.1 Reliability Test Item

Test Items	Test Conditions	Notes
High Temperature Storage	100°C, 1,000hr.	0/20
Low Temperature Storage	-40°C, 1,000hr.	0/20
Temp. Humidity Storage	60°C, 90% RH, 1,000hr.	0/20
Steady State Operating life	25°C, 30mA , 1,000hr.	0/20
High Temperature Operating Life	85°C, 10mA, 1,000hr.	0/20
Low Temperature Operating Life	-30°C, 20mA, 1,000hr.	0/20
Steady State Operating life Of High Humidity Heat	60°C, 90% RH, 15mA, 1,000hr.	0/20
Thermal Shock	-40°C (30min) ↔ 100°C (30min.), 100 cycle	0/20
ESD	HBM, 100 pF, 1.5 kΩ, 3 times	0/20

### 9.2 Criteria for Judging the Damage

Items	Test Conditions	Criteria for judgment
Luminous Intensity ( $I_V$ )	$I_F = 20\text{mA}$	> 70% of S
Forward Voltage ( $V_F$ )	$I_F = 20\text{mA}$	Less than 110% of U

\* U means the upper limit of specified characteristics, S means initial value.

# 3mm Dome LED Lamp IWL-R3R65F-XXX



## 10. Part Name Description

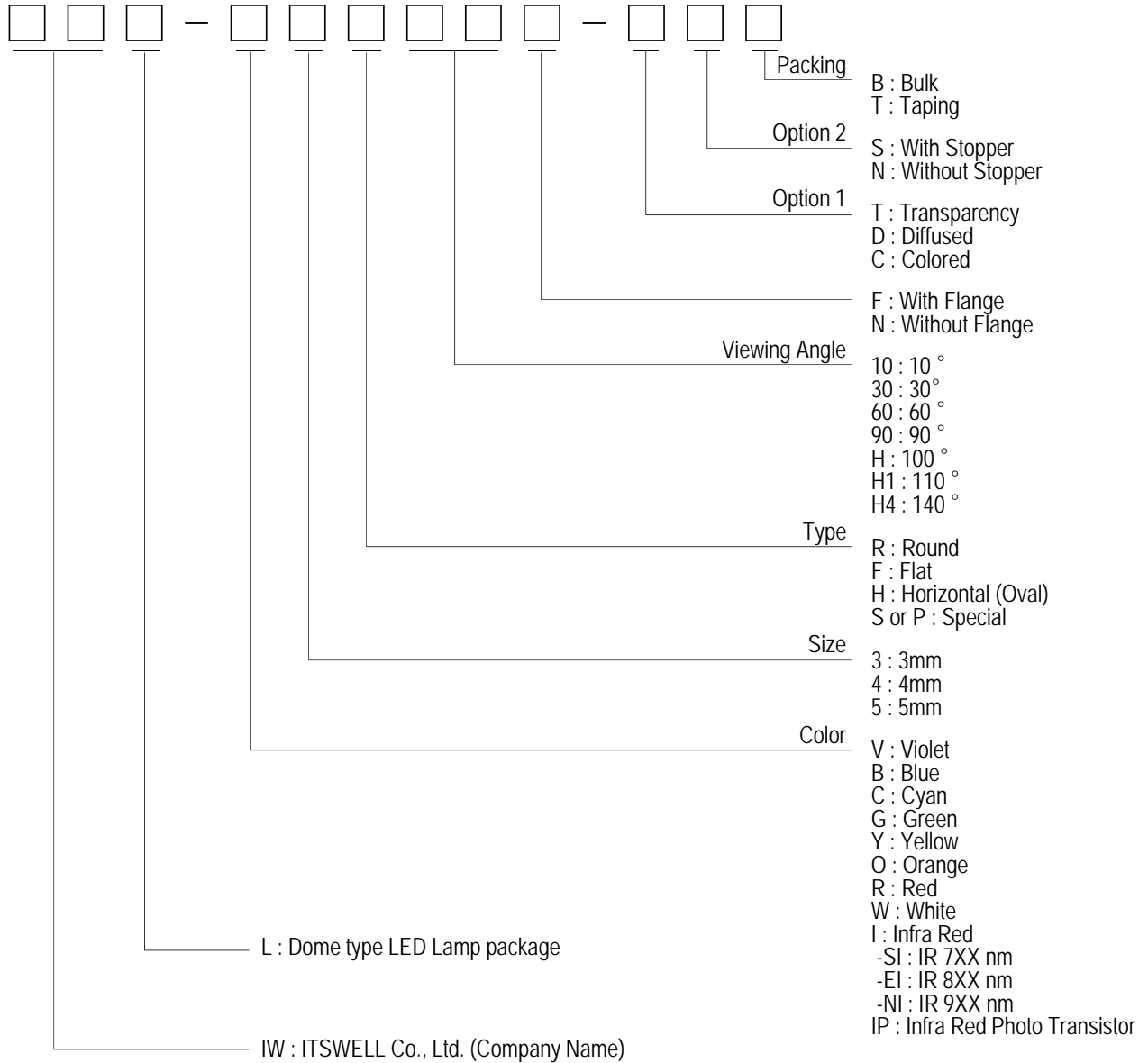

## 11. Attention : Electric Static Discharge (ESD) Protection



The symbol shown on the page herein to introduce 'Electro-Optical Characteristics'. ESD protection for GaP and AlGaAs based chips is still necessary even though they are safe in low static-electric discharge. Material in AlInGaP, GaP, or/and InGaN based chips are STATIC SENSITIVE devices. ESD protection has to be considered and taken in the initial design stage. If manual work/process is needed, please ensure the device is well protected from ESD during all the process.



■ Spec. Review History

<b>Review Ver.</b>	<b>Date</b>	<b>Correction List</b>	<b>Etc.</b>
<b>Ver 1.0</b>	<b>2006.06.19</b>	<b>Establish</b>	
<b>Ver 1.1</b>	<b>2008.06.10</b>	<b>Revision</b>	
<b>Ver 2.0</b>	<b>2013.07.26</b>	<b>Revision</b>	